

**FIRST<sup>®</sup> LEGO<sup>®</sup> League**

**TUTORIALS**

teach

share

learn

**ATAŞAMENTE PASIVE**

SESHAN BROTHERS

# CE ESTE UN ATAȘAMENT?

- Un mecanism pe care îl construiești care poate asista robotul în îndeplinirea unei sarcini (e.g. Ridicarea unui obiect, lăsarea unui obiect).
- Acest mecanism este „atașat” la baza robotului.
- Pentru robotul de competiție, ținta este să realizați un design al atașamentelor care să funcționeze constant de fiecare dată și să fie ușor de adăugat și înlăturat.

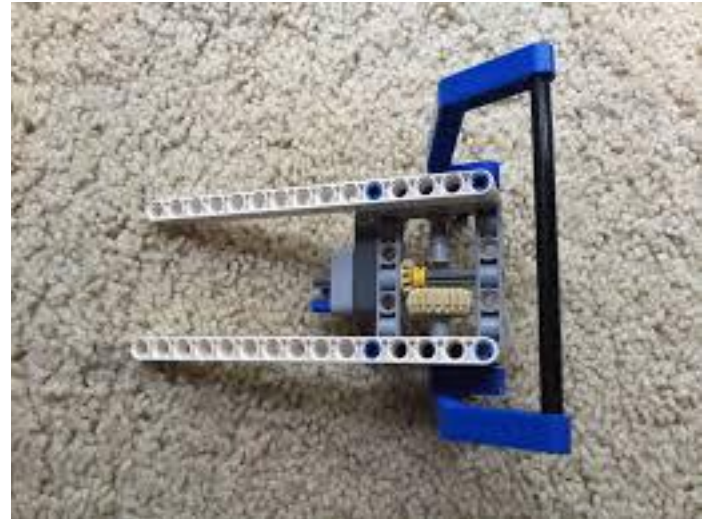

# PASIV VS. ALIMENTATE

- Atașamentele pasive nu au nevoie de putere externă. Ele tipic funcționează pe baza mișcării robotului sau simplu utilizează gravitația.
  - Această lecție acoperă câteva tipuri simple de atașamente pasive.
- Atașamente alimentate au nevoie de o anumită sursă de putere. Aceasta include puterea unui motor, pneumatica sau alte surse.

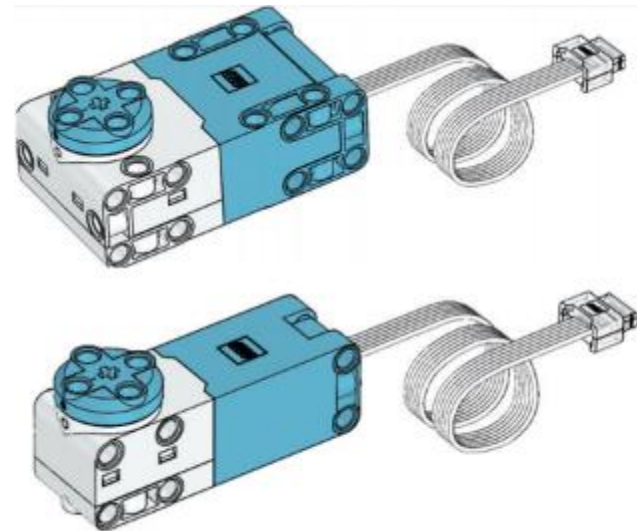
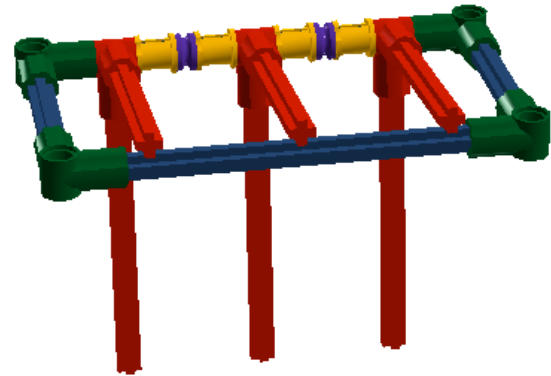



# UNUL – POARTA CU UN SINGUR SENS SAU CORTINA

- Atașamentul pasiv care lasă obiectele să intre dar nu să iasă
- Utilizează gravitația
- Poate fi realizat în orice dimensiune





2 x  1/2 BUSH - Medium Lilac

4 x  BUSH FOR CROSS AXLE - Flame Yellowish Orange

2 x  CROSS AXLE 5M - Earth Blue

3 x  CROSS AXLE 6M - Bright Red

3 x  CROSS AXLE 8M - Bright Red

1 x  CROSS AXLE 10M - Black

1 x  CROSS AXLE 10M - Earth Blue

3 x  ANGLE ELEMENT, 90 DEGREES [6] - Bright Red

4 x  ANGLE ELEMENT, 90 DEGREES [6] - Earth Green

# ÎNCERCAȚI SĂ CONSTRUIȚI UNUL...

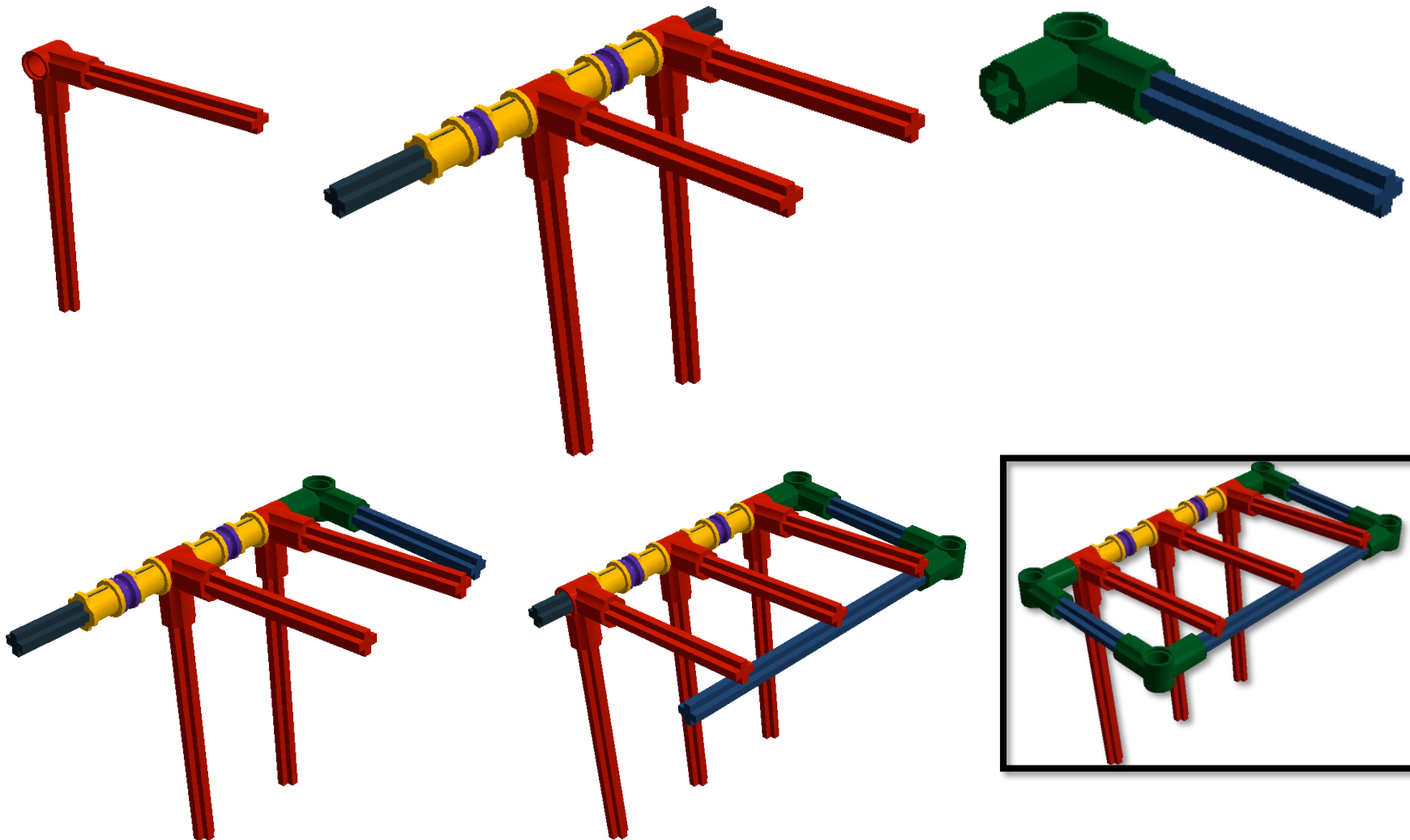



# CARABINIERĂ

- Atașamentul pasiv lasă obiectele să intre dar nu să iasă
- Se poate utiliza gravitatea sau benzile de cauciuc.
- Poate fi modificat la orice dimensiune





1 x  TECHNIC 15M BEAM - Bright Reddish Violet

4 x  TECHNIC ANG. BEAM 3X5 90 DEG. - Bright Blue

2 x  TECHNIC ANG. BEAM 3X5 90 DEG. - Bright Green

2 x  TECHNIC ANGULAR BEAM 3X7 - Bright Red

4 x  1/2 BUSH - Bright Yellow

1 x  CROSS AXLE 3M - Flame Yellowish Orange

4 x  BUSH FOR CROSS AXLE - Medium Stone Grey

2 x  CROSS AXLE 4M - Black

8 x  CONNECTOR PEG W. FRICTION 3M - Flame Yellowish Orange

1 x  3M CONNECTOR PEG - Flame Yellowish Orange

# ÎNCERCAȚI SĂ CONSTRUIȚI UNUL...

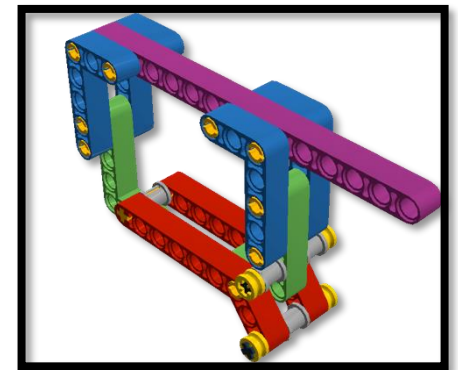
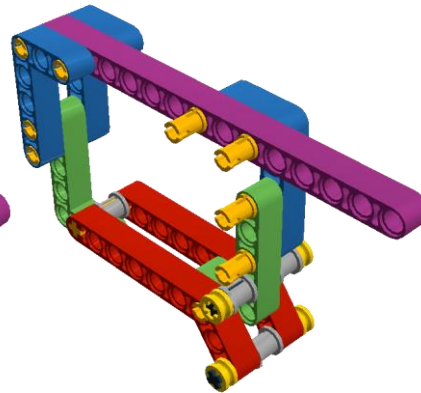
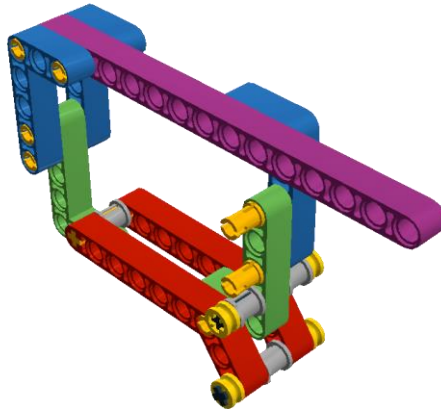
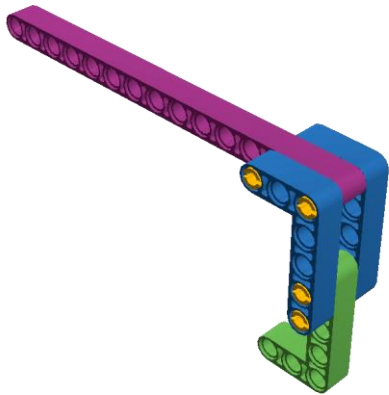
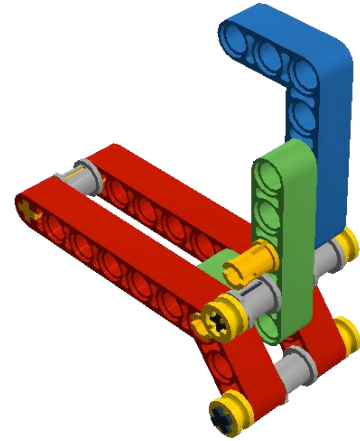
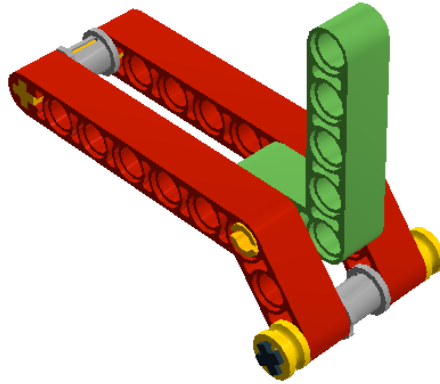
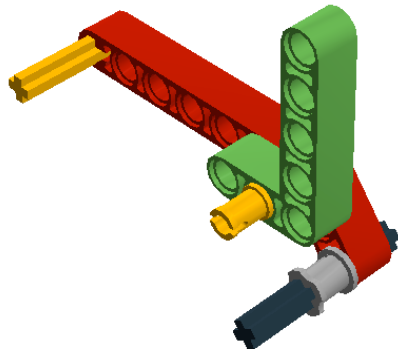

Add rubber bands on bushings as needed

# CREDITS

- Această lecție a fost scrisă de Arvind și Sanjay Seshan
- Mai multe lecții despre FIRST LEGO League sunt disponibile pe [www.flltutorials.com](http://www.flltutorials.com)
- Această lecție a fost tradusă în limba română de echipa FTC Rosophia #21455



This work is licensed under a [Creative Commons Attribution-NonCommercial-ShareAlike 4.0 International License](https://creativecommons.org/licenses/by-nc-sa/4.0/).